

# Daisy Chain Series Quick Start Guide

## DVD/CD Duplicator Controls:

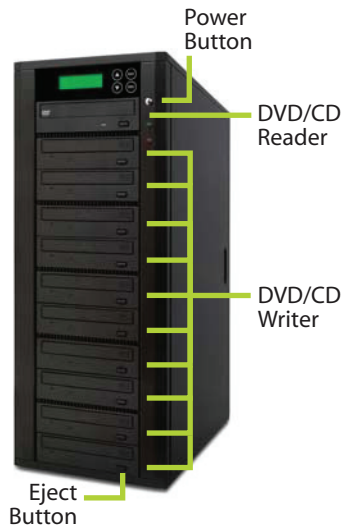

## Package Contents:

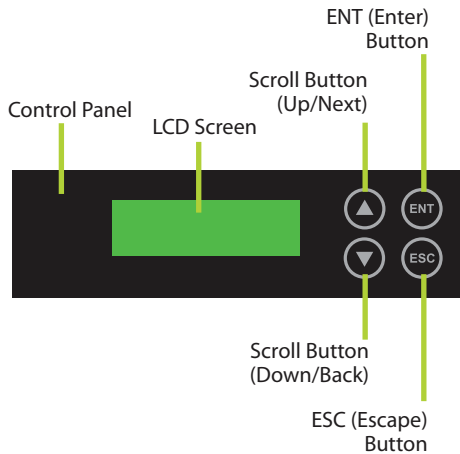

### Step 1

Remove unit from box and place upright on a flat surface. Save packing material for storage and transport.



### Step 2

Connect the AC Power cord to all of the units and plug the other end into an AC wall outlet.



### Step 3

Connect the Green end of the RJ-45 link cable to the "MASTER" port (sender port) of the first duplicator tower (back).



### Step 4

Connect the Blue end of the RJ-45 link cable to the "SLAVE" port (receiver port) of the second duplicator tower (back).



*Note: Repeat Steps 3 & 4 if more towers are present starting with the second duplicator tower.*

### Step 5

Turn the duplicator towers ON by pressing the power button located on the front of each duplicator tower.



### Step 6

In order to Set up or Link the Daisy Chain Duplicators you must first set the link position by using the arrow keys ▼▲ select "12. Link Setup" from the display menu options. Press ENT. Then press ENT again when the screen prompts "1. Set My Position." Using the arrow keys, select "First" for the first tower and "Last" for the second tower. Press ENT to confirm selection, then press ESC to return to the main menu. Turn OFF all towers.

*Note: When connecting three or more towers use "First" for the first tower, "Last" for the last tower and "Middle" for all of the towers in between.*

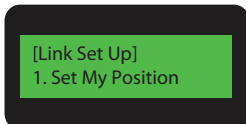
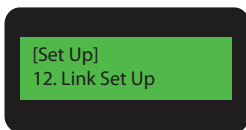

### Step 7

Turn ON towers (see Step 5). The LCD screen will display the total number of drives detected and the number of towers detected. When the LCD screen shows "1. Copy," the units are ready for use.

*(Note: The LCD screen shown here is an example of three 10-target towers linked properly together.)*

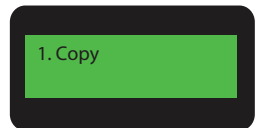
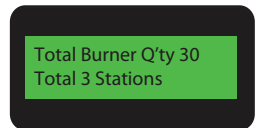

### Step 8

To begin the copying process, press the eject button on the top drive of the first tower (DVD/CD Reader/Writer Drive). When the tray opens, place the Master Disc in the tray and press the eject (close) button to close the tray.



### Step 9

Press the eject button on all writer drives, on all towers. Place blank recordable CD or DVD discs in the trays and press the eject (close) button to close the trays.

*(DVD/CD write drives must be loaded with blank recordable DVD/CD discs.)*

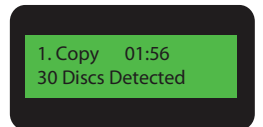

### Step 10

After completing Steps 8 & 9, the copy process will automatically begin.

*(Copying status will be displayed on the LCD Screen.)*



### Step 11

Upon completion of the copy process, the completed discs will automatically be ejected. Remove all completed discs and repeat steps 8-10 to continue the copying process as necessary.

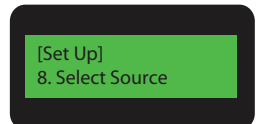

### Selecting Source (Optional)

To select between hard drive and reader drive as the source, select "8. Select Source" from the main menu and press ENT. Use the ▼ and ▲ arrow to toggle between HDD and ROM.

