



# **iOpen Pro Series HDD Duplicator**

## **User's Manual**

# Table of Contents

<b>I.</b>	<b>Introduction</b>	4
	1 Features	4
	2 Control Panel Overview	4
	3 Specifications	5
<b>II.</b>	<b>Warning</b>	5
<b>III.</b>	<b>Synchronous/Asynchronous Mode</b>	6
	1 Synchronous Mode	6
	2 Asynchronous Mode	6
<b>IV.</b>	<b>Menu Overview</b>	7
	1 Copy	7
	2 Compare	7
	3 Copy + Compare	7
	4 Capacity Check	8
	5 Utility	8
	5.1 Format FAT32	8
	5.2 Format exFAT	8
	5.3 Measure Speed	9
	5.4 Quick Erase	9
	5.5 Full Erase	9
	5.6 DOD Erase	9
	5.7 Change Disk Signatures	10
	5.8 Media Information	10
	5.9 Device Model	10
	5.10 System Information	10
	5.11 System Update	11
	6 Setup	11
	6.1 Copy Area	11
	6.2 Asynchronous Mode	12
	6.3 Smaller Target	12

6.4	Unknown Format	12
6.5	Check Before Copy	12
6.6	Display Mode	12
6.7	Start-up Menu	13
6.8	Button Beep	13
6.9	Show Result Time	13
6.10	Boot Password	14
6.11	Setup Password	14
6.12	Language	14
6.13	Clear Setup	14
6.14	Performance	15

# I. Introduction

This duplicator system is designed and developed based on the FPGA from the world famous semiconductor company XILINX. Every processing channel is parallel to each other with its own control unit, therefore the duplicator will not sacrifice speed for the increasing number of targets loaded - always remain the same and fast copy speed. The duplicator supports fast copy with multiple file formats created by three major operating systems (Windows/Linux/MAC), and makes mirror copies of data efficiently. GPT and MBR partition formats, and 4K advanced format hard disk drive (HDD) are all supported. Furthermore, this duplicator has been fully tested with quality assurance before leaving our manufacturing facility.

## 1. Features

- a. Each processing channel has its own control unit and operates independently with dedicated bandwidth of up to 300 MB/S or 18 GB/Min (SATA2).
- b. Standalone operation. No PC or software is required, minimizing possible computer virus infection.
- c. Instant power on and off, no warm-up or cool-down required.
- d. Easy-to-use One-Touch copy operation.
- e. Compare function available for verification of copy accuracy
- f. Menu options are user-friendly and easily accessed through the 4-button control panel. Use ▲ or ▼ button to scroll through the options and view the operation status of each channel on the 2-line backlit LCD display.
- g. All functions support synchronous and asynchronous mode to achieve higher efficiency.
- h. Powerful 32-bit CRC checksum to assure data integrity.
- i. Heavy-duty hardware construction for commercial production or personal use.
- j. 115V and 230V switching power supply maximizes portability for operation anywhere.
- k. Designed to save users time and effort in creating multiple copies quickly and reliably.
- l. Unique source data analysis to copy data area only to achieve highest efficiency
- m. Supports multiple file formats: Windows: FAT 16/32、exFAT、NTFS, Linux: Ext 2/3/4, Mac: HFS/HFS+
- n. Fan Auto Control system starts and stops fan running automatically according to the process of task.
- o. With over-voltage protection the duplicator system shuts down power supply automatically to protect hard disk drive from damage when the power supply is unstable.

## 2. Control Panel Overview

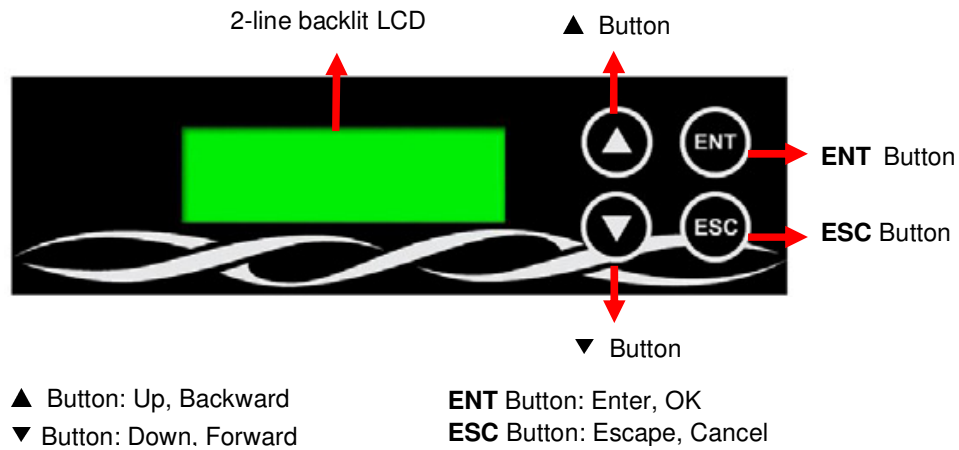

### 3. Specifications

\*Product specs may change without notice

<b>Operation</b>	Standalone (No PC or software is required)	
<b>Supported HDD</b>	2.5" and 3.5" SATA HDD ( SATA I, II, III) and SSD	
<b>Display</b>	2-line Backlit Monochrome LCD	
<b>Power Supply</b>	115V or 230V	
<b>Control Button</b>	4 push-button control panel (ENT, ESC, UP, DOWN )	
<b>Humidity</b>	Working	20% ~ 80%
	Storage	5% ~ 95%
<b>Temperature</b>	Working	32°F ~ 167°F
	Storage	-4°F ~ 185°F

## II. Warning

1. The duplicator tasks mentioned in this user's manual are as following: Copy, Compare, Copy + Compare, Capacity Check, and the functions under Utility sub menu, such as Format FAT32, Format exFAT, Quick Erase, Full Erase and DOD Erase.

2. The Green LED flashes during the execution process of a task. After the task is done, the Green LED will stay solid if the process is successful, otherwise the Red LED will be on if the process is failed.
3. Press and hold **ESC** button during the execution process of a task will stop and exit the execution of the task.
4. DO NOT unplug HDD from the duplicator during the execution process of a task. It may cause damage to the duplicator system and HDD.
5. It is strongly recommended that the capacities of the source and target HDD are equal or similar.

### III. Synchronous/Asynchronous Mode

#### 1. Synchronous Mode (Default)

Synchronous Mode means that the duplicator will start to execute a task after the source and target devices have been inserted and the ENT button is pressed. The task will begin and end at the same time for all target devices. Any other target device plugged in during the process of a task will not be executed with the task. Go to section **6.2 Asynchronous Mode** to enable or disable this function.

- a. Insert source media into the source channel and blank media into the target channels properly. The LCD display will show no source disk when source media is not plugged in yet, and show the number of target media inserted when source media plugged in.
- b. The green LED will be on if the target device is plugged in properly.
- c. Select the task from menu, and press **ENT** button to execute it.
- d. During the execution process, the status of each target device can be checked by using the ▲ and ▼ buttons.
- e. After the task is done, LCD display will show the number of successful and failed target(s), and execution time. Go to section **6.9 Show Result Time** to set up the display of time.

#### 2. Asynchronous Mode

Asynchronous Mode means that the duplicator will read the data from source device into system memory buffer and start to execute a task immediately when target device(s) inserted. Duplicator does not have to wait for all target device(s) inserted in order to start the execution of the task at the same time. No matter the data size of the source device, duplicator can asynchronously execute a task if Asynchronous Mode is enabled. Go to **6.2 Asynchronous Mode** to enable or disable this function.

- a. Insert source media into the source channel, select the task to execute from the menu, and press **ENT** button. Duplicator will start to execute the task now.
- b. Target devices can be plugged in during the execution process, and will start to execute the task immediately

- c. Target device can be removed when it finishes the execution process and its green LED is solid on. New target device can be plugged into the same channel for execution of the task again.
- d. LCD display will show the percentage of execution process, the number of successful and failed target(s). Here the percentage of execution process displayed is only for the least processed target device.
- e. During the execution process, the status of each target device can be checked by using the ▲ and ▼ buttons.
- f. After the task is done for all target devices, press ESC button to exit from the task. LCD display will show the total number of successful and failed target(s), and total execution time. Go to **6.9 Show Result Time** to set up the display of time.
- g. Don't need to wait for all target devices to be done. Each channel executes the task asynchronously.

## IV. Menu Overview

### 1. Copy:

To copy from source HDD to target HDD(s), please go to **6.1 Copy Area** to select the setting first before this step.

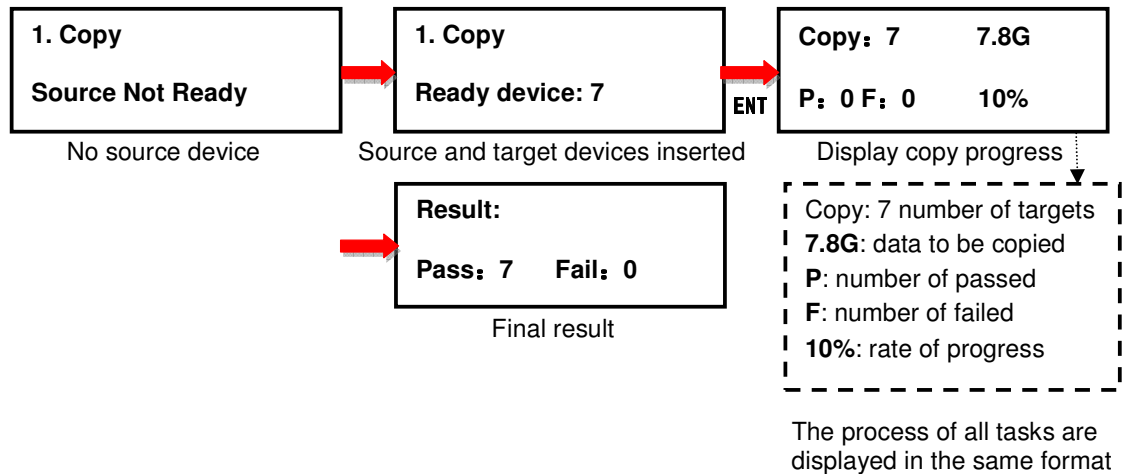

### 2. Compare:

This command allows to compare the copied target HDD devices against the source for accuracy.

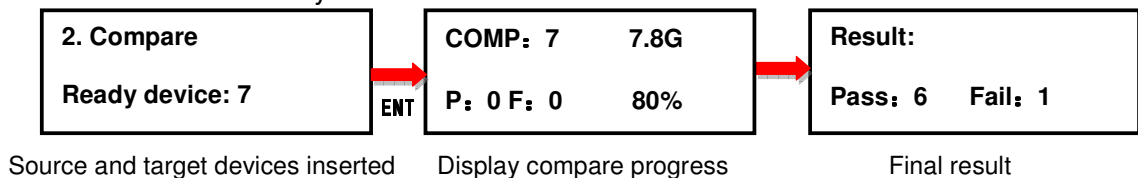

### 3. Copy + Compare

This command allows duplicator to start Copy process first, then follow with Compare process immediately.

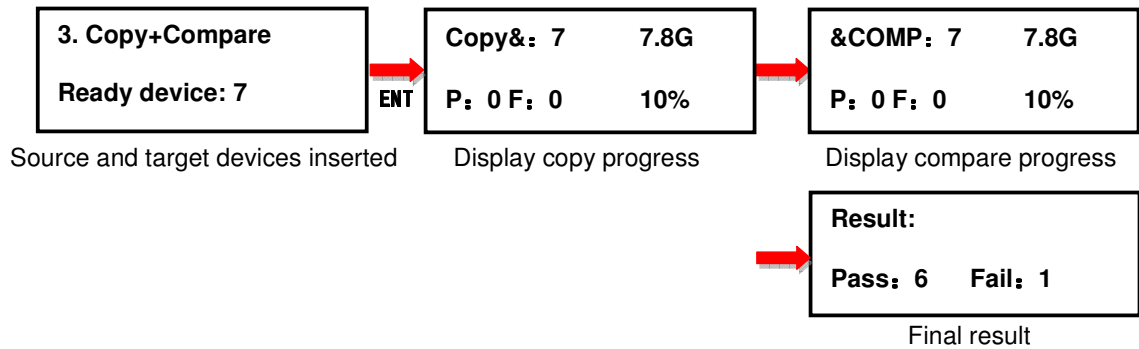

#### 4. Capacity Check

This command allows to verify the HDD device capacity. It can detect the actual capacity of devices within 3 seconds.

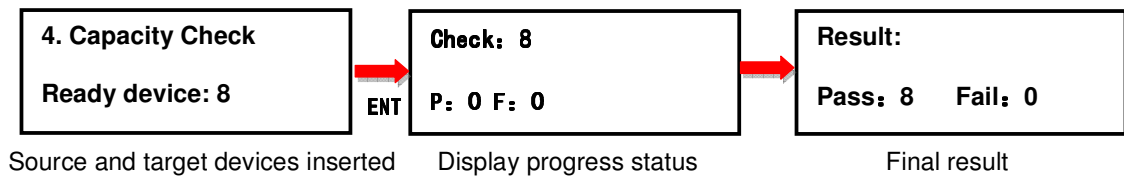

#### 5. Utility

##### 5.1 Format FAT32

This option allows to format the target device to FAT32 file format. It will not format the source device, avoiding accidentally erasing the original data content. User will be asked if it is sure to format the target devices before the Format process starts.

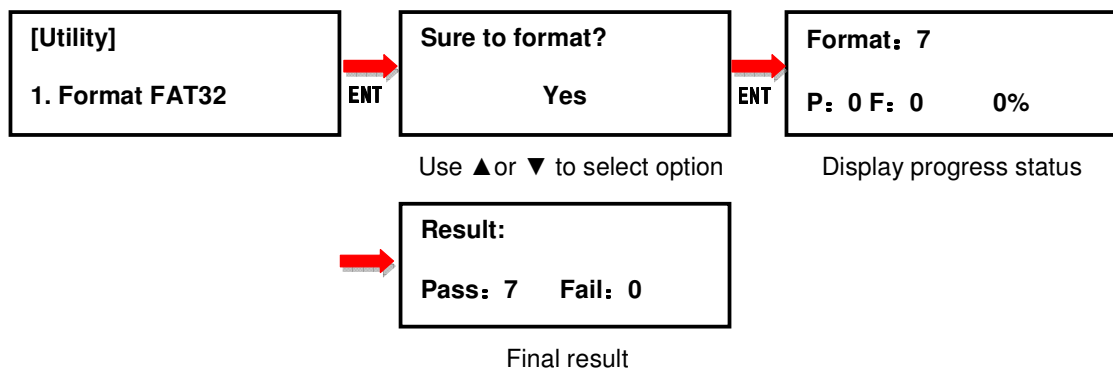

##### 5.2 Format exFAT

This option allows to format the target device to exFAT file format. It will not format the source device, avoiding accidentally erasing the original data content. User will be asked if it is sure to format the target devices before the Format process starts.



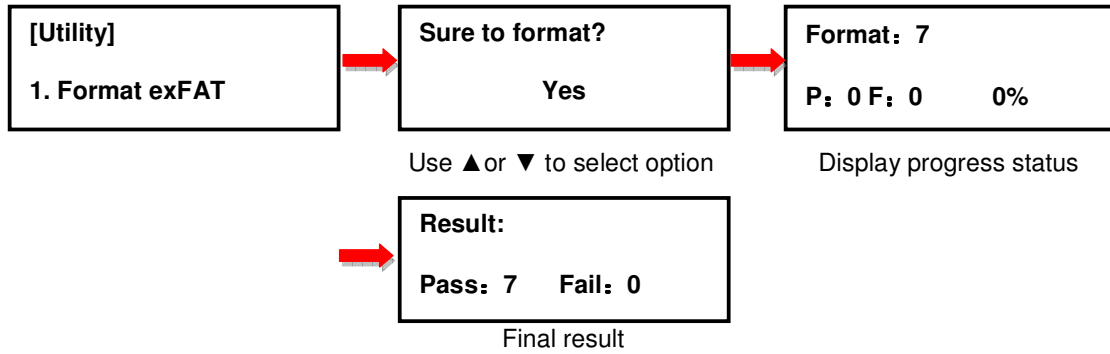

### 5.3 Measure Speed

This option allows to measure the actual Read and Write speed of the target device. This option will NOT alter or erase existing data on the target device.

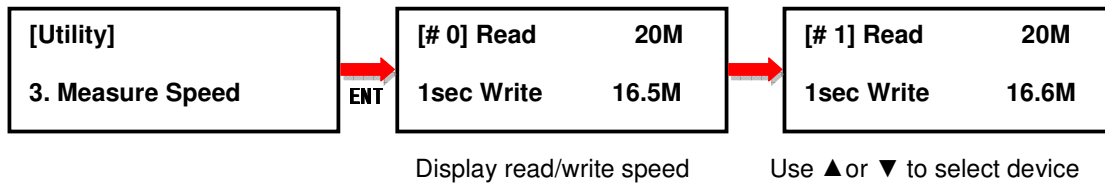

### 5.4 Quick Erase

This option erases the table of content of file system of the target device, so it is fast to do Quick Erase. There is chance that some files can be retrieved by software.

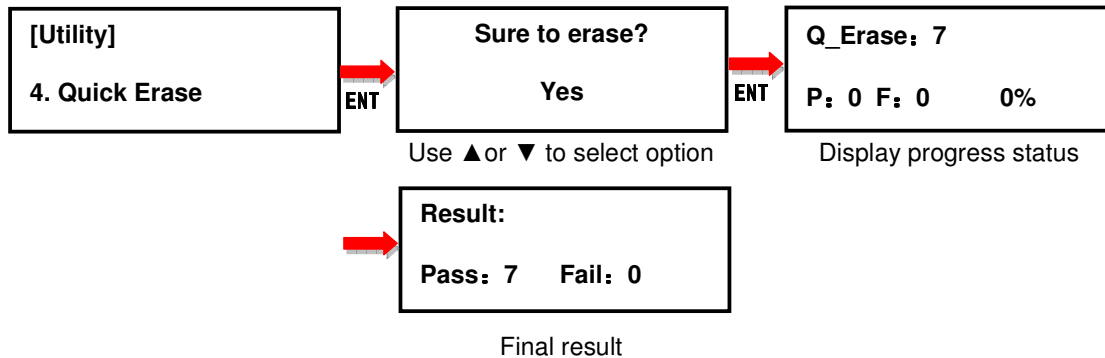

### 5.5 Full Erase

This option completely erases the content of target device. It takes longer time to erase and the content will not be retrieved by software.

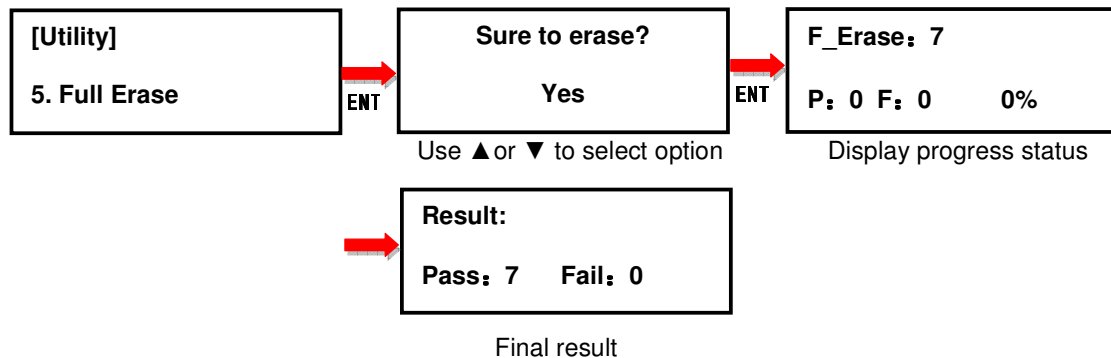

### 5.6 DoD Erase

This is to comply with the U.S.A. Department of Defense (DoD 5220) standard to fully erase the HDD by rewriting bit by bit three times to guarantee the data to

be permanently deleted. It takes the longest time to erase, and the content will not be retrieved by software.

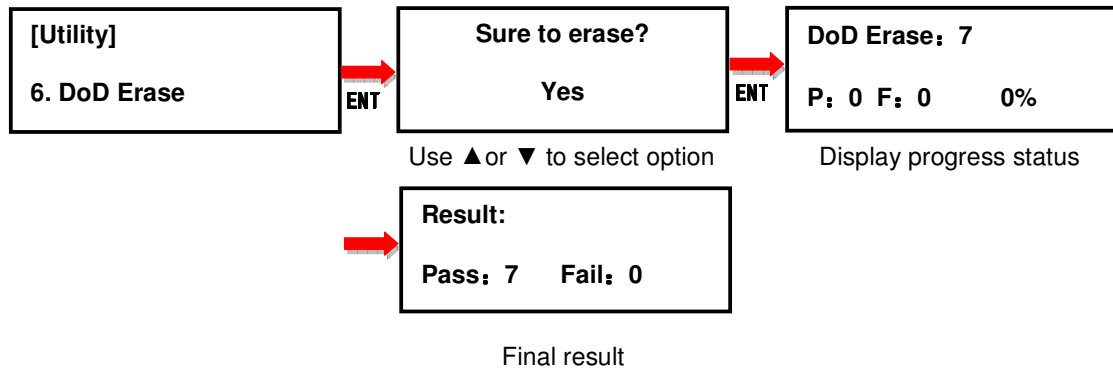

### 5.7 Change Disk Signatures

Duplicator generates the same disk signatures after copy which may cause computer unable to read the disk correctly when two disks with identical disk signatures are presented, or shut down the computer. This function allows to change disk signature. Attention: it will cause error (data mismatch) if compare the disks after execution of this function.

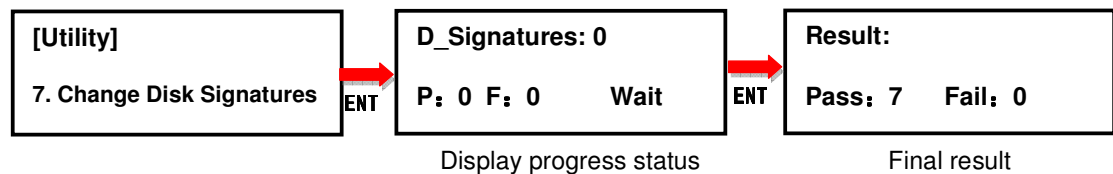

### 5.8 Media Information

This option displays the information of selected HDD device, such as total capacity, file format and the size of data content.

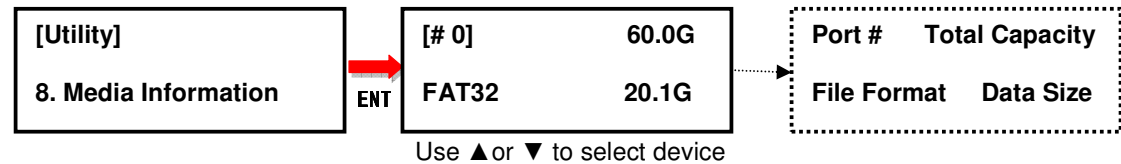

### 5.9 Device Model

This option displays the model information of selected HDD device, such as device model, serial information and firmware version

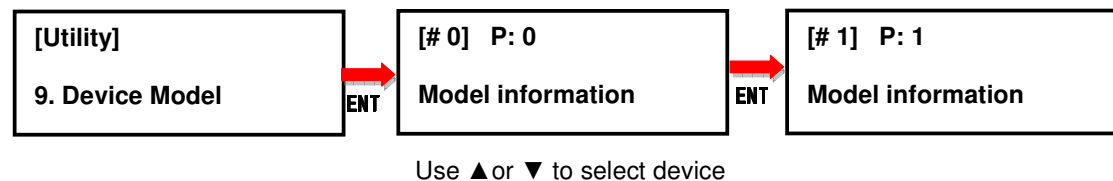

### 5.10 System Information

This option displays general information of the duplicator, including controller model, system memory size, firmware version and number of targets.

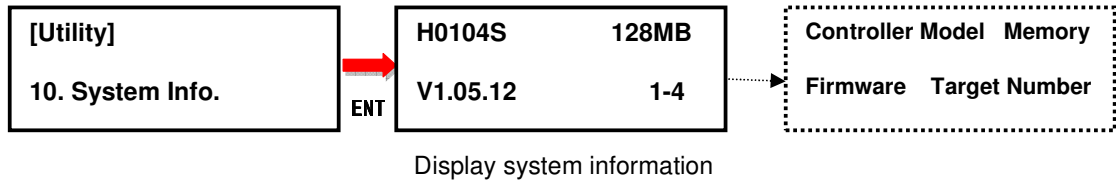

### 5.11 System Update

This option allows user to update the firmware of duplicator when necessary. Please obtain the proper firmware file from manufacturer, and save the unzipped file under home folder on the flash device (DO NOT save the file under sub folder). Insert the flash device containing the firmware into the source port of duplicator and press ENT. It will update the system, reboot the duplicator after update, active and operate under the new firmware.

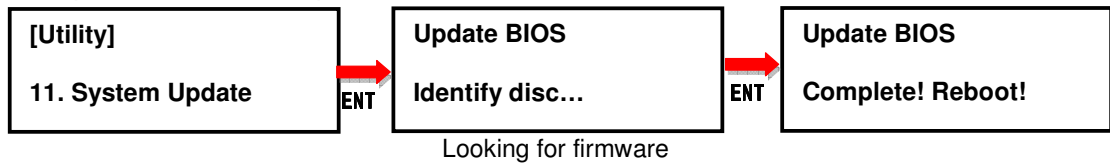

## 6. Setup

### 6.1 Copy Area

This option allows to select the area on the source device to copy onto the target devices. You may select either "System And Files" to skip all the unoccupied area on the source device or "Whole Media". By default, the copy area is set up as System And Files.

#### 6.1.1 System And Files

The duplicator first analyzes the file format of source HDD device. You may copy only the system and files area to save overall copy time if the file format is FAT16, FAT32, exFAT, NTFS (Windows), EXT2, EXT3, EXT4 (Linux), and HFS/HFS+ (Mac). Otherwise, the duplicator will copy the entire source device content to the target devices including unoccupied space. For instance, the source HDD has 2TB capacity but with only 50MB of data in FAT32 file format. The duplicator will copy only the 50MB of data area to the target HDD(s), hence shortening overall copy time.

#### 6.1.2 Whole Media

When selected, the duplicator copies the entire content on the source HDD device, including both the data and empty spaces. This option is used when you have a source device with unknown file format. For instance a source HDD has 2TB capacity and 50MB of data with unknown file format, the duplicator will copy the whole 2TB of content to target HDD(s).

## 6.2 Asynchronous Mode

This option allows to enable or disable Asynchronous Mode. By default the Asynchronous Mode is disabled. Please refer to Chapter III for the detail of operation on Synchronous and Asynchronous Mode.

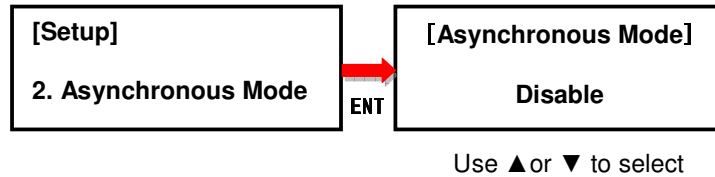

## 6.3 Smaller Target

If the capacity of the target HDD is smaller than the source HDD, the duplicator will partly copy or cannot copy. Cannot Copy is the default setting.

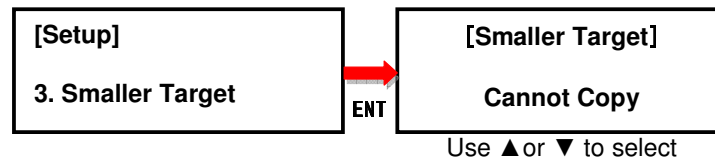

## 6.4 Unknown Format

This option allows you to Copy or Skip unknown format. If option Skip is selected here, the unknown format from source will not be copied during copy process. Copy unknown format is the default setting.

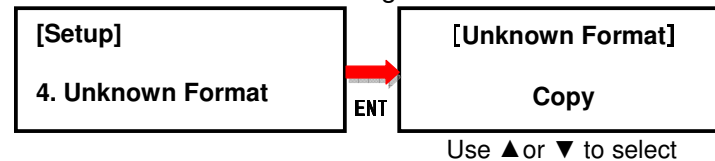

## 6.5 Check Before Copy

This option allows to check device real capacity before copying. By default this option is disabled.

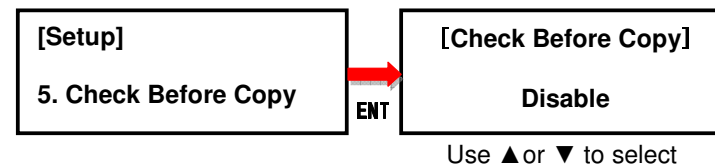

## 6.6 Display Mode

There are three display modes: Basic, Show Timer, and Expert. Basic Mode shows the copy progress in general; Show Timer Mode displays the time used for the task; Expert Mode shows the devices with highest copy speed and lowest copy speed and their copy progress respectively. By default it is Basic Mode.

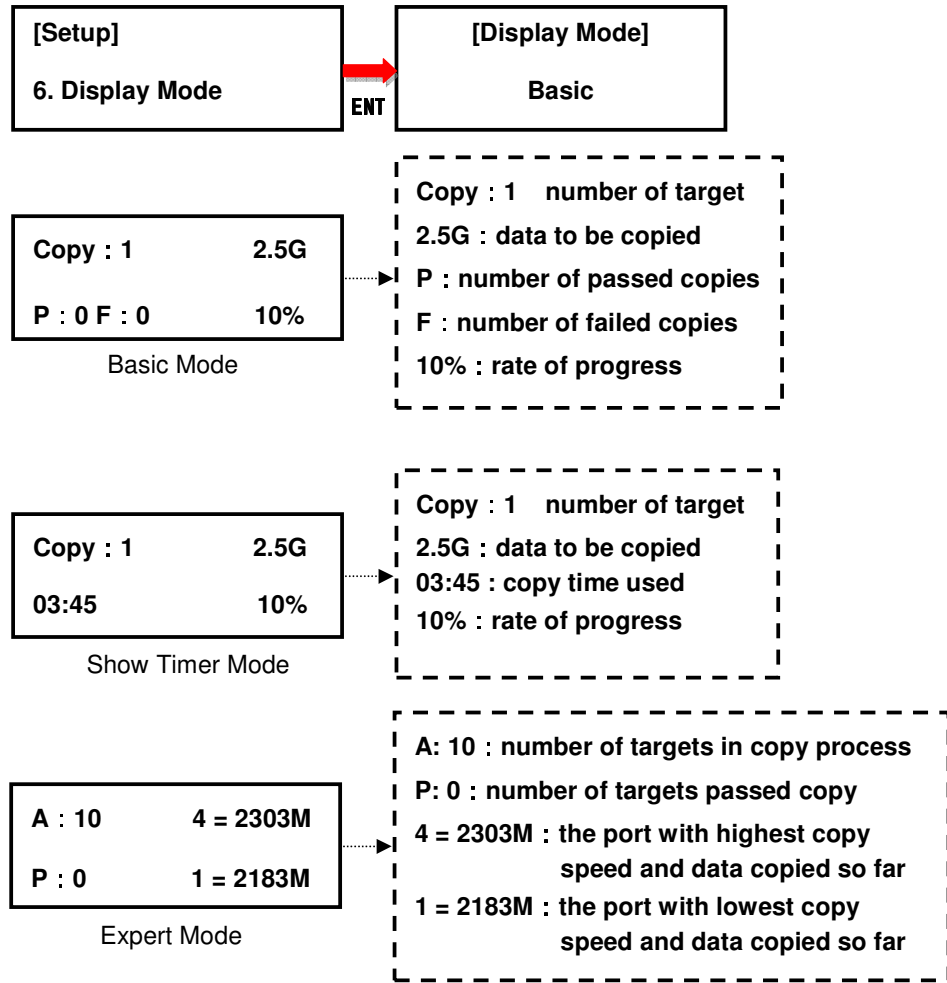

### 6.7 Start-up Menu

Choose one of the following as the default start-up function: Copy, Compare, Copy+Compare, Capacity Check, Utility and Setup. The default start-up function is Copy.

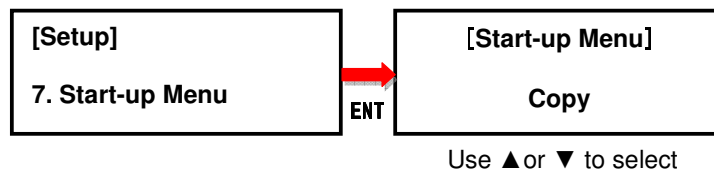

### 6.8 Button Beep

This option allows to set up button sound from the following options: Button & Warning, OFF, Warning only. The default setting is Button & Warning.

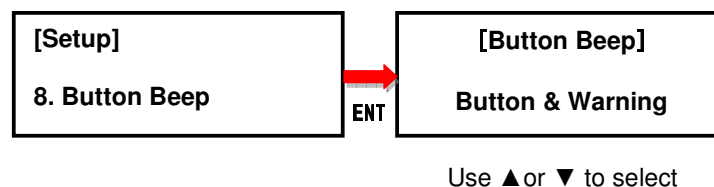

### 6.9 Show Result Time

This option allows to enable or disable the display of copy time after finishing the

copy process. The default setting is disable.

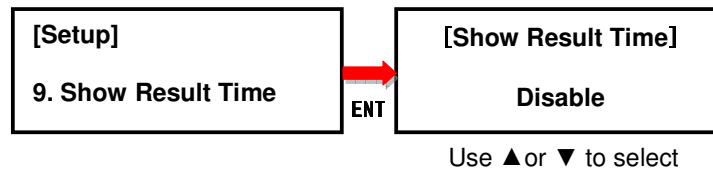

### 6.10 Boot Password

This option allows to set up password for system boot up to prevent from the unauthorized use of the duplicator. The password must be 6 characters.

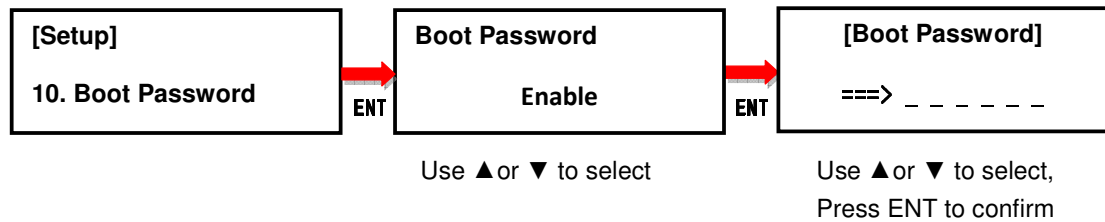

### 6.11 Setup Password

This option allows to set up password for Setup function to prevent from the change of system settings on the duplicator. The password must be 6 characters.

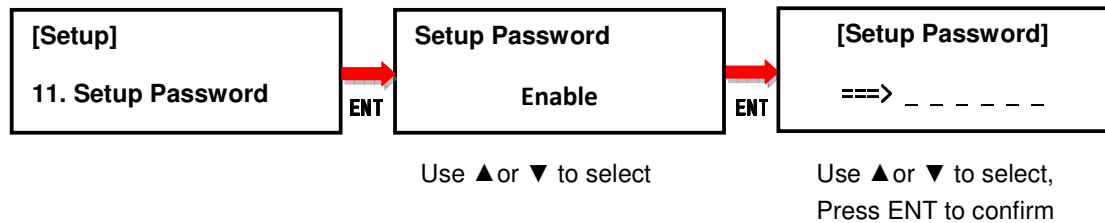

### 6.12 Language

This option allows to choose the language for display: English, Spanish, Portuguese, and Japanese. English is the default language.

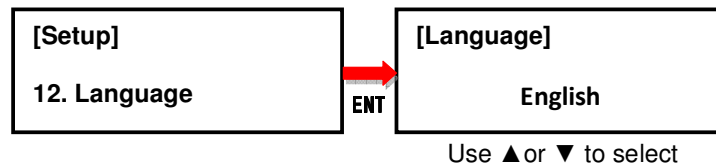

### 6.13 Clear Setup

This option resets the duplicator back to factory default settings.

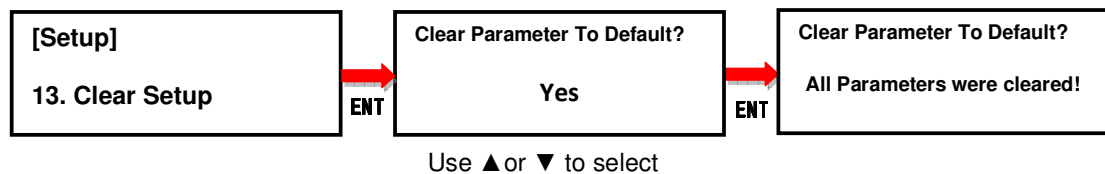

## 6.14 Performance

This option allows to set up the performance for Copy function based on the following modes: Speed, Balance, and Compatibility. Speed mode is to execute the Copy function at the fastest speed, but may have compatibility issue with certain brands flash media. Balance mode is to execute the Copy function at stable speed, and have less compatibility issue with certain brands flash media. Compatibility mode is to execute the Copy function at the most stable speed, and almost have no compatible issue with flash media. The default mode is Speed.

